

SN74AHC1G32 Single 2-Input Positive-OR Gate

1 Features

- Operating range of 2V to 5.5V
- Max t_{pd} of 6.5ns at 5V
- Low power consumption, 10 μ A max I_{CC}
- ± 8 mA output drive at 5V
- Schmitt-trigger action at all inputs makes the circuit tolerant for slower input rise and fall time
- Latch-up performance exceeds 250mA per JESD 17

2 Applications

- AV Receivers
- Portable Audio Docks
- Blu-Ray Players and Home Theaters
- MP3 Players and Recorders
- Personal Digital Assistants (PDAs)
- Power:
 - Telecom and Server AC DC Supply
 - Single Controllers
 - Analog
 - Digital
- Client and Enterprise Solid State Drives (SSDs)
- LCD and Digital TVs and High-Definition TVs (HDTVs)
- Enterprise Tablets
- Video Analytics Servers
- Wireless Headsets, Keyboards, and Mice

3 Description

The SN74AHC1G32 device is a single 2-input positive-OR gate. The device performs the Boolean function $Y = A + B$ or $Y = \overline{A} \cdot \overline{B}$ in positive logic.

Package Information

PART NUMBER	PACKAGE ⁽¹⁾	PACKAGE SIZE ⁽²⁾	BODY SIZE ⁽³⁾
SN74AHC1G32	DBV (SOT-23, 5)	2.90mm × 2.8mm	2.90mm × 1.60mm
	DCK (SC70, 5)	2.00mm × 2.1mm	2.00mm × 1.25mm
	DRL (SOT, 5)	1.60mm × 1.6mm	1.60mm × 1.20mm

- (1) For more information, see [Section 11](#).
- (2) The package size (length × width) is a nominal value and includes pins, where applicable.
- (3) The body size (length × width) is a nominal value and does not include pins.



Simplified Schematic



Table of Contents

1 Features	1	7.3 Feature Description.....	8
2 Applications	1	7.4 Device Functional Modes.....	8
3 Description	1	8 Application and Implementation	9
4 Pin Configuration and Functions	3	8.1 Application Information.....	9
5 Specifications	4	8.2 Typical Application.....	9
5.1 Absolute Maximum Ratings.....	4	8.3 Power Supply Recommendations.....	10
5.2 ESD Ratings.....	4	8.4 Layout.....	10
5.3 Recommended Operating Conditions.....	4	9 Device and Documentation Support	11
5.4 Thermal Information.....	5	9.1 Documentation Support (Analog).....	11
5.5 Electrical Characteristics.....	5	9.2 Receiving Notification of Documentation Updates....	11
5.6 Switching Characteristics, $V_{CC} = 3.3\text{ V} \pm 0.3\text{ V}$	5	9.3 Support Resources.....	11
5.7 Switching Characteristics, $V_{CC} = 5\text{ V} \pm 0.5\text{ V}$	6	9.4 Trademarks.....	11
5.8 Operating Characteristics.....	6	9.5 Electrostatic Discharge Caution.....	11
5.9 Typical Characteristics.....	6	9.6 Glossary.....	11
6 Parameter Measurement Information	7	10 Revision History	11
7 Detailed Description	8	11 Mechanical, Packaging, and Orderable Information	12
7.1 Overview.....	8		
7.2 Functional Block Diagram.....	8		

4 Pin Configuration and Functions

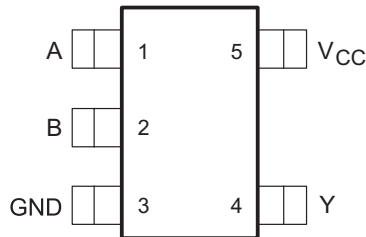

Figure 4-1. DBV Package 5-Pin SOT-23 Top View

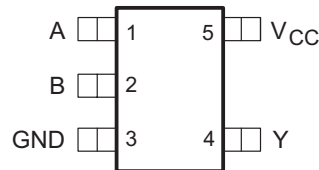
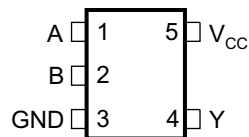

Figure 4-2. DCK Package 5-Pin SC70 Top View



See mechanical drawings for dimensions.

Figure 4-3. DRL Package 5-Pin SOT Top View

Table 4-1. Pin Functions

PIN		TYPE ⁽¹⁾	DESCRIPTION
NO.	NAME		
1	A	I	Input A
2	B	I	Input B
3	GND	—	Ground Pin
4	Y	O	Output Y
5	V _{CC}	—	Power Pin

(1) Signal Types: I = Input, O = Output, I/O = Input or Output

5 Specifications

5.1 Absolute Maximum Ratings

over operating free-air temperature range (unless otherwise noted) ⁽¹⁾

		MIN	MAX	UNIT
V _{CC}	Supply voltage	-0.5	7	V
V _I	Input voltage ⁽²⁾	-0.5	7	V
V _O	Output voltage ⁽²⁾	-0.5	V _{CC} + 0.5	V
I _{IK}	Input clamp current	(V _I < 0)	-20	mA
I _{OK}	Output clamp current	(V _O < 0 or V _O > V _{CC})	±20	mA
I _O	Continuous output current	(V _O = 0 to V _{CC})	±25	mA
	Continuous current through V _{CC} or GND		±50	mA
T _J	Maximum junction temperature		150	°C
T _{stg}	Storage temperature	-60	150	°C

- (1) Stresses beyond those listed under *Absolute Maximum Ratings* may cause permanent damage to the device. These are stress ratings only, and functional operation of the device at these or any other conditions beyond those indicated under *Recommended Operating Conditions* is not implied. Exposure to absolute-maximum-rated conditions for extended periods may affect device reliability.
- (2) The input and output voltage ratings may be exceeded if the input and output current ratings are observed.

5.2 ESD Ratings

		VALUE	UNIT
V _(ESD)	Electrostatic discharge	Human body model (HBM), per ANSI/ESDA/JEDEC JS-001 ⁽¹⁾	±1500
		Charged device model (CDM), per JEDEC specification JESD22-C101 ⁽²⁾	±1000

- (1) JEDEC document JEP155 states that 500-V HBM allows safe manufacturing with a standard ESD control process.
- (2) JEDEC document JEP157 states that 250-V CDM allows safe manufacturing with a standard ESD control process.

5.3 Recommended Operating Conditions

over operating free-air temperature range (unless otherwise noted)⁽¹⁾

		MIN	MAX	UNIT
V _{CC}	Supply voltage	2	5.5	V
V _{IH}	High-level input voltage	V _{CC} = 2 V	1.5	V
		V _{CC} = 3 V	2.1	
		V _{CC} = 5.5 V	3.85	
V _{IL}	Low-level input voltage	V _{CC} = 2 V	0.5	V
		V _{CC} = 3 V	0.9	
		V _{CC} = 5.5 V	1.65	
V _I	Input voltage	0	5.5	V
V _O	Output voltage	0	V _{CC}	V
I _{OH}	High-level output current	V _{CC} = 2 V	-50	μA
		V _{CC} = 3.3 V ± 0.3 V	-4	mA
		V _{CC} = 5 V ± 0.5 V	-8	
I _{OL}	Low-level output current	V _{CC} = 2 V	50	μA
		V _{CC} = 3.3 V ± 0.3 V	4	mA
		V _{CC} = 5 V ± 0.5 V	8	
Δt/Δv	Input transition rise and fall rate	V _{CC} = 3.3 V ± 0.3 V	100	ns/V
		V _{CC} = 5 V ± 0.5 V	20	
T _A	Operating free-air temperature	-40	125	°C

- (1) All unused inputs of the device must be held at V_{CC} or GND to ensure proper device operation. See [Implications of Slow or Floating CMOS Inputs](#), SCBA004.

5.4 Thermal Information

THERMAL METRIC ⁽¹⁾		SN74AHC1G32			UNIT
		DBV (SOT-23)	DCK (SC70)	DRL (SOT)	
		5 PINS	5 PINS	5 PINS	
R _{θJA}	Junction-to-ambient thermal resistance	278	293.4	328.7	°C/W
R _{θJC(top)}	Junction-to-case (top) thermal resistance	180.5	208.8	105.1	°C/W
R _{θJB}	Junction-to-board thermal resistance	184.4	180.6	150.3	°C/W
ψ _{JT}	Junction-to-top characterization parameter	115.4	120.6	6.9	°C/W
ψ _{JB}	Junction-to-board characterization parameter	183.4	179.5	148.4	°C/W
R _{θJC(bot)}	Junction-to-case (bottom) thermal resistance	N/A	N/A	N/A	°C/W

(1) For more information about traditional and new thermal metrics, see the [Semiconductor and IC Package Thermal Metrics](#) application report.

5.5 Electrical Characteristics

over recommended operating free-air temperature range (unless otherwise noted)

PARAMETER	TEST CONDITIONS	V _{CC}	T _A = 25°C			-40 TO +80°C		-40 TO +125°C		UNIT	
			MIN	TYP	MAX	MIN	MAX	MIN	MAX		
V _{OH} High level output voltage	I _{OH} = -50 μA	2 V	1.9	2		1.9		1.9	V		
		3 V	2.9	3		2.9		2.9			
		4.5 V	4.4	4.5		4.4		4.4			
	I _{OH} = -4 mA	3 V	2.58			2.48		2.48			
		4.5 V	3.94			3.8		3.8			
V _{OL} Low level output voltage	I _{OL} = 50 μA	2 V			0.1		0.1		v		
		3 V			0.1		0.1				
		4.5 V			0.1		0.1				
	I _{OL} = 4 mA	3 V			0.36		0.44				
		4.5 V			0.36		0.44				
I _{OL} = 8 mA	3 V			0.36		0.44					
	4.5 V			0.36		0.44					
I _I Input leakage current	V _I = 5.5 V or GND	0 V to 5.5 V			±0.1		±1		±1	μA	
I _{CC} Supply current	V _I = V _{CC} or GND, I _O = 0	5.5 V			1		10		10	μA	
C _i Input Capacitance	V _I = V _{CC} or GND	5 V			2	10		10		10	pF

5.6 Switching Characteristics, V_{CC} = 3.3 V ± 0.3 V

over recommended operating free-air temperature range (unless otherwise noted) (see [Load Circuit And Voltage Waveforms](#))

PARAMETER	FROM (INPUT)	TO (OUTPUT)	LOAD CAPACITANCE	T _A = 25°C			-40°C to +85°C			-40°C to +125°C			UNIT
				MIN	TYP	MAX	MIN	TYP	MAX	MIN	TYP	MAX	
t _{PLH}	A or B	Y	C _L = 15 pF	5.5	7.9		1		9.5	1		10	ns
t _{PHL}				5.5	7.9		1		9.5	1		10	
t _{PLH}	A or B	Y	C _L = 50 pF	8	11.4		1		13	1		14	ns
t _{PHL}				8	11.4		1		13	1		14	

5.7 Switching Characteristics, $V_{CC} = 5 V \pm 0.5 V$

over recommended operating free-air temperature range (unless otherwise noted) (see [Load Circuit And Voltage Waveforms](#))

PARAMETER	FROM (INPUT)	TO (OUTPUT)	LOAD CAPACITANCE	$T_A = 25^\circ C$			$-40^\circ C$ to $+85^\circ C$			$-40^\circ C$ to $+125^\circ C$			UNIT
				MIN	TYP	MAX	MIN	TYP	MAX	MIN	TYP	MAX	
t_{PLH}	A or B	Y	$C_L = 15\text{ pF}$		3.8	5.5	1	6.5	1	7	ns		
t_{PHL}					3.8	5.5	1	6.5	1	7			
t_{PLH}	A or B	Y	$C_L = 50\text{ pF}$		5.3	7.5	1	8.5	1	9.5	ns		
t_{PHL}					5.3	7.5	1	8.5	1	9.5			

5.8 Operating Characteristics

$V_{CC} = 5 V, T_A = 25^\circ C$

PARAMETER	TEST CONDITIONS	TYP	UNIT
C_{pd}	Power dissipation capacitance No load, $f = 1\text{ MHz}$	14	pF

5.9 Typical Characteristics

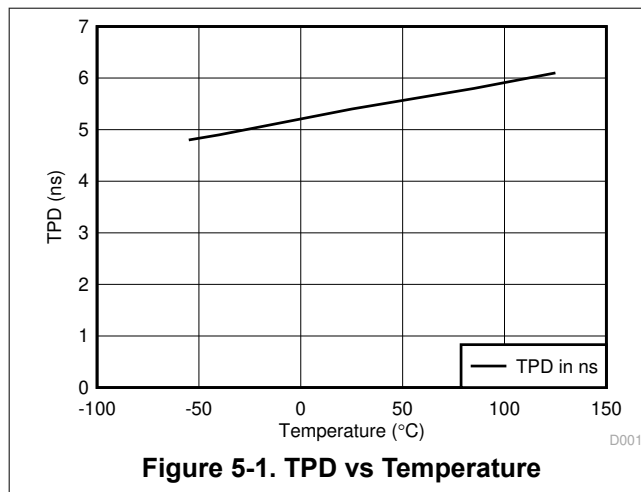

Figure 5-1. TPD vs Temperature

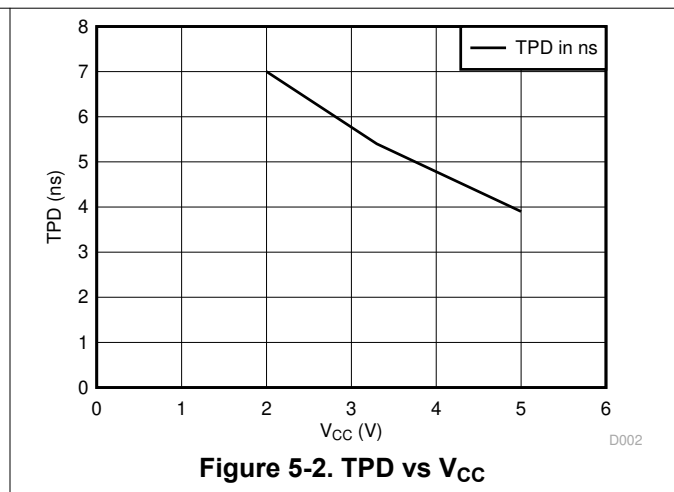
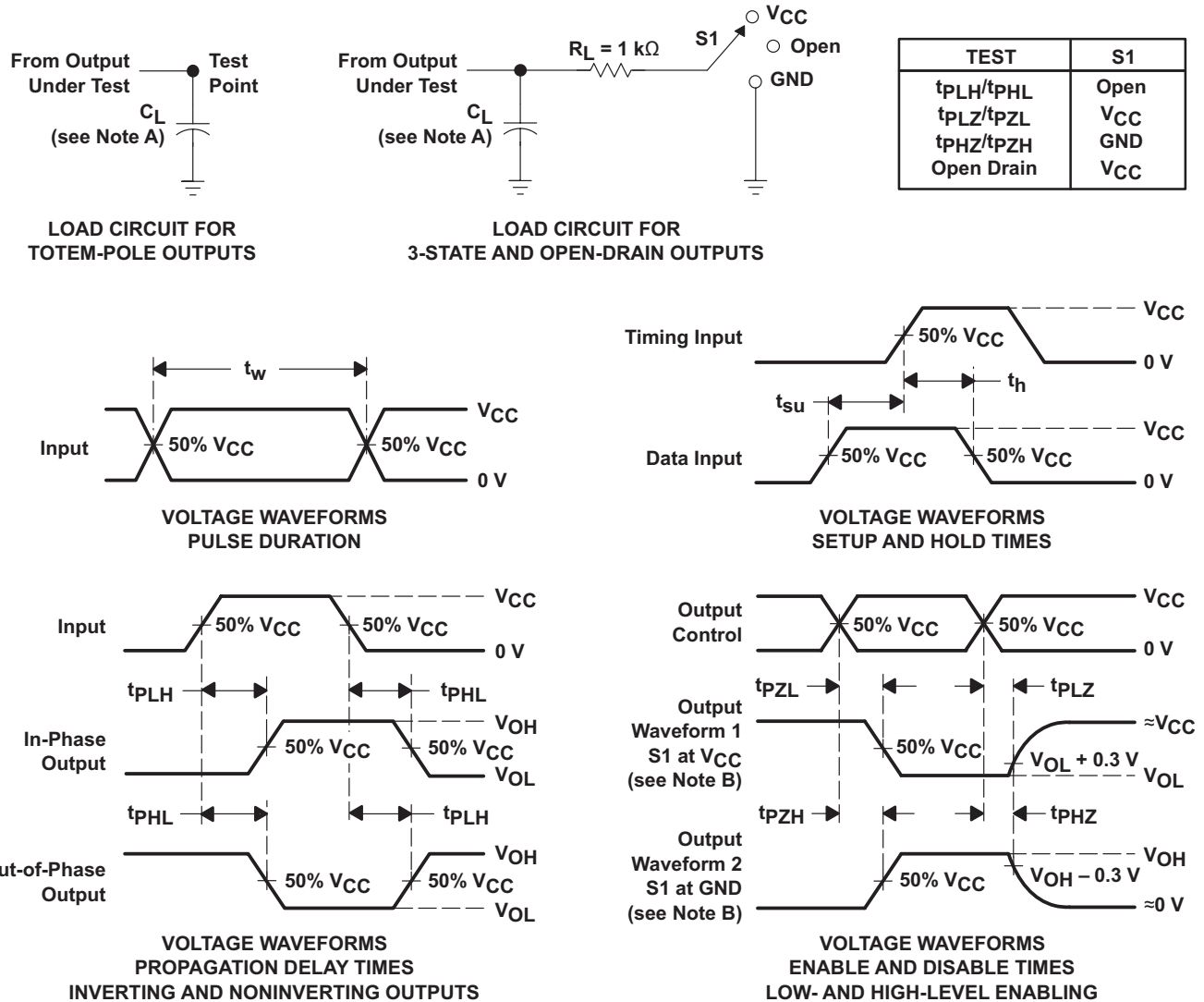

Figure 5-2. TPD vs V_{CC}

6 Parameter Measurement Information



- NOTES: A. C_L includes probe and jig capacitance.
 B. Waveform 1 is for an output with internal conditions such that the output is low, except when disabled by the output control. Waveform 2 is for an output with internal conditions such that the output is high, except when disabled by the output control.
 C. All input pulses are supplied by generators having the following characteristics: PRR $\leq 1\text{ MHz}$, $Z_O = 50\ \Omega$, $t_r \leq 3\text{ ns}$, $t_f \leq 3\text{ ns}$.
 D. The outputs are measured one at a time, with one input transition per measurement.
 E. All parameters and waveforms are not applicable to all devices.

Figure 6-1. Load Circuit and Voltage Waveforms

7 Detailed Description

7.1 Overview

The SN74AHC1G32 device is a single 2-input positive OR gate with low drive that produces slow rise and fall times. This reduces ringing on the output signal. The device also has Schmitt-trigger action that will allow for slower or noisier inputs. The input signals are high impedance when $V_{CC} = 0$ V.

7.2 Functional Block Diagram



7.3 Feature Description

- Wide operating voltage
 - Operates from 2 V to 5.5 V
- Allows down voltage translation
 - Accepts input voltages to 5.5 V

7.4 Device Functional Modes

Table 7-1 shows the functional modes of the SN74AHC1G32 device.

Table 7-1. Function Table

INPUTS ⁽¹⁾		OUTPUT ⁽²⁾
A	B	Y
H	X	H
X	H	H
L	L	L

(1) H = High Voltage Level, L = Low Voltage Level, X = Don't Care

(2) H = Driving High, L = Driving Low, Z = High Impedance State

8 Application and Implementation

Note

Information in the following applications sections is not part of the TI component specification, and TI does not warrant its accuracy or completeness. TI's customers are responsible for determining suitability of components for their purposes, as well as validating and testing their design implementation to confirm system functionality.

8.1 Application Information

The SN74AHC1G32 is a low-drive CMOS device that can be used for a multitude of bus-interface type applications where output ringing is a concern. The low drive and slow edge rates will minimize overshoot and undershoot on the outputs. The inputs can accept voltages to 5.5 V at any valid V_{CC} making it ideal for down translation.

8.2 Typical Application

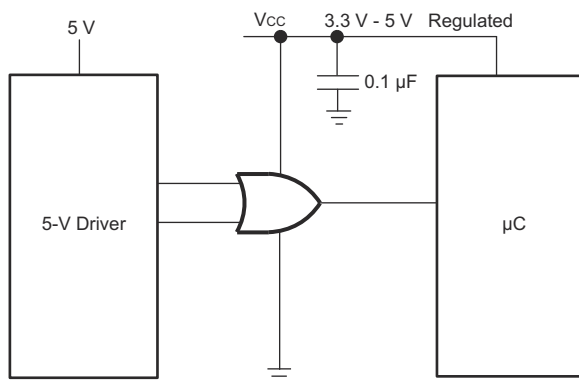

Figure 8-1. Specific Application Schematic

8.2.1 Design Requirements

This device uses CMOS technology and has balanced output drive. Take care to avoid bus contention because it can drive currents that would exceed maximum limits. The high drive will also create fast edges into light loads so routing and load conditions should be considered to prevent ringing.

8.2.2 Detailed Design Procedure

- Recommended input conditions
 - Specified high and low levels. See (V_{IH} and V_{IL}) in the [Section 5.3](#) table.
 - Inputs are overvoltage tolerant allowing them to go as high as 5.5 V at any valid V_{CC}
- Recommended output conditions
 - Load currents should not exceed 25 mA per output and 50 mA total for the part
 - Outputs should not be pulled above V_{CC}

8.2.3 Application Curve

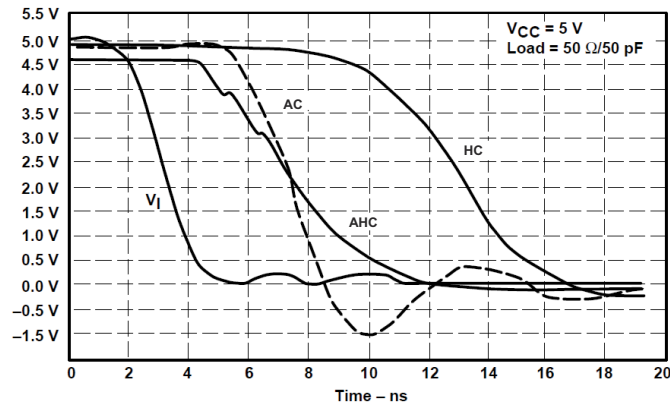

Figure 8-2. Switching Characteristics Comparison

8.3 Power Supply Recommendations

The power supply can be any voltage between the MIN and MAX supply voltage rating located in the [Section 5.3](#) table.

Each V_{CC} pin should have a good bypass capacitor to prevent power disturbance. For devices with a single supply, 0.1 μF is recommended; if there are multiple V_{CC} pins, then 0.01 μF or 0.022 μF is recommended for each power pin. It is acceptable to parallel multiple bypass caps to reject different frequencies of noise. A 0.1 μF and a 1 μF are commonly used in parallel. The bypass capacitor should be installed as close to the power pin as possible for best results.

8.4 Layout

8.4.1 Layout Guidelines

When using multiple-bit logic devices, inputs should never float.

In many cases, functions or parts of functions of digital logic devices are unused, for example, when only two inputs of a triple-input AND gate are used or only 3 of the 4 buffer gates are used. Such input pins should not be left unconnected because the undefined voltages at the outside connections result in undefined operational states. [Figure 8-3](#) specifies the rules that must be observed under all circumstances. All unused inputs of digital logic devices must be connected to a high or low bias to prevent them from floating. The logic level that should be applied to any particular unused input depends on the function of the device. Generally they will be tied to GND or V_{CC} , whichever makes more sense or is most convenient. It is generally acceptable to float outputs, unless the part is a transceiver. If the transceiver has an output enable pin, it will disable the output section of the part when asserted. This will not disable the input section of the I/Os, so they cannot float when disabled.

8.4.2 Layout Example

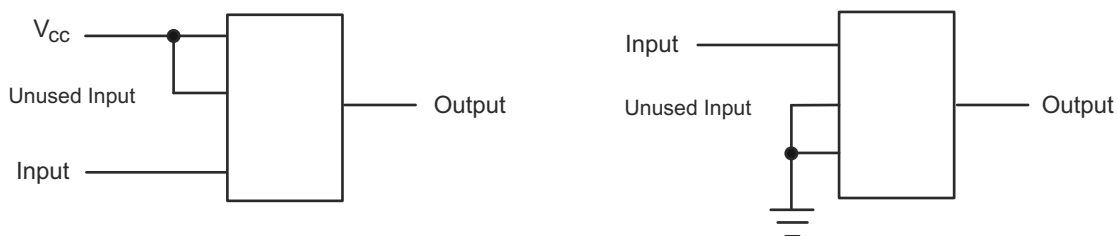

Figure 8-3. Layout Diagram

9 Device and Documentation Support

9.1 Documentation Support (Analog)

9.1.1 Related Links

The table below lists quick access links. Categories include technical documents, support and community resources, tools and software, and quick access to sample or buy.

Table 9-1. Related Links

PARTS	PRODUCT FOLDER	SAMPLE & BUY	TECHNICAL DOCUMENTS	TOOLS & SOFTWARE	SUPPORT & COMMUNITY
SN74AHC1G32	Click here	Click here	Click here	Click here	Click here

9.2 Receiving Notification of Documentation Updates

To receive notification of documentation updates, navigate to the device product folder on ti.com. Click on *Subscribe to updates* to register and receive a weekly digest of any product information that has changed. For change details, review the revision history included in any revised document.

9.3 Support Resources

[TI E2E™ support forums](#) are an engineer's go-to source for fast, verified answers and design help — straight from the experts. Search existing answers or ask your own question to get the quick design help you need.

Linked content is provided "AS IS" by the respective contributors. They do not constitute TI specifications and do not necessarily reflect TI's views; see TI's [Terms of Use](#).

9.4 Trademarks

TI E2E™ is a trademark of Texas Instruments.
All trademarks are the property of their respective owners.

9.5 Electrostatic Discharge Caution



This integrated circuit can be damaged by ESD. Texas Instruments recommends that all integrated circuits be handled with appropriate precautions. Failure to observe proper handling and installation procedures can cause damage.

ESD damage can range from subtle performance degradation to complete device failure. Precision integrated circuits may be more susceptible to damage because very small parametric changes could cause the device not to meet its published specifications.

9.6 Glossary

[TI Glossary](#) This glossary lists and explains terms, acronyms, and definitions.

10 Revision History

NOTE: Page numbers for previous revisions may differ from page numbers in the current version.

Changes from Revision P (February 2017) to Revision Q (April 2024) Page

- Updated the numbering, formatting, tables, figures and cross-references throughout the document to reflect modern datasheet standards..... **1**
- Updated RθJA values: DBV = 231.3 to 278, DCK = 287.6 to 293.4; Updated DBV and DCK packages for RθJC(top), RθJB, ΨJT, ΨJB, and RθJC(bot), all values in °C/W **5**

Changes from Revision O (July 2014) to Revision P (February 2017) Page

- Changed *Handling Ratings* table to *ESD Ratings* table..... **4**
- Added MAX values for T_A = 25°C in both *Switching Characteristics* tables. **5**

11 Mechanical, Packaging, and Orderable Information

The following pages include mechanical, packaging, and orderable information. This information is the most current data available for the designated devices. This data is subject to change without notice and revision of this document. For browser-based versions of this data sheet, refer to the left-hand navigation.

PACKAGING INFORMATION

Orderable Device	Status (1)	Package Type	Package Drawing	Pins	Package Qty	Eco Plan (2)	Lead finish/ Ball material (6)	MSL Peak Temp (3)	Op Temp (°C)	Device Marking (4/5)	Samples
SN74AHC1G32DBVR	ACTIVE	SOT-23	DBV	5	3000	RoHS & Green	NIPDAU SN	Level-1-260C-UNLIM	-40 to 125	(39CH, A323, A32G, A32J, A32L, A32S)	Samples
SN74AHC1G32DBVRE4	ACTIVE	SOT-23	DBV	5	3000	RoHS & Green	NIPDAU	Level-1-260C-UNLIM	-40 to 125	A32G	Samples
SN74AHC1G32DBVRG4	ACTIVE	SOT-23	DBV	5	3000	RoHS & Green	NIPDAU	Level-1-260C-UNLIM	-40 to 125	A32G	Samples
SN74AHC1G32DBVT	OBSOLETE	SOT-23	DBV	5		TBD	Call TI	Call TI	-40 to 125	(A323, A32G, A32J, A32S)	
SN74AHC1G32DBVTG4	OBSOLETE	SOT-23	DBV	5		TBD	Call TI	Call TI	-40 to 125	A32G	
SN74AHC1G32DCK3	ACTIVE	SC70	DCK	5	3000	RoHS & Non-Green	SNBI	Level-1-260C-UNLIM	-40 to 85	AGY	Samples
SN74AHC1G32DCKR	ACTIVE	SC70	DCK	5	3000	RoHS & Green	SN	Level-1-260C-UNLIM	-40 to 125	(1RA, AG3, AGG, AGJ, AGL, AGS)	Samples
SN74AHC1G32DCKRE4	ACTIVE	SC70	DCK	5	3000	RoHS & Green	NIPDAU	Level-1-260C-UNLIM	-40 to 125	AG3	Samples
SN74AHC1G32DCKRG4	ACTIVE	SC70	DCK	5	3000	RoHS & Green	NIPDAU	Level-1-260C-UNLIM	-40 to 125	AG3	Samples
SN74AHC1G32DCKT	OBSOLETE	SC70	DCK	5		TBD	Call TI	Call TI	-40 to 125	(AG3, AGG, AGJ, AGS)	
SN74AHC1G32DCKTE4	ACTIVE	SC70	DCK	5	250	RoHS & Green	NIPDAU	Level-1-260C-UNLIM	-40 to 125	AG3	Samples
SN74AHC1G32DCKTG4	ACTIVE	SC70	DCK	5	250	RoHS & Green	NIPDAU	Level-1-260C-UNLIM	-40 to 125	AG3	Samples
SN74AHC1G32DRLR	ACTIVE	SOT-5X3	DRL	5	4000	RoHS & Green	NIPDAU NIPDAUAG	Level-1-260C-UNLIM	-40 to 125	(AGB, AGS)	Samples
SN74AHC1G32DRLRG4	ACTIVE	SOT-5X3	DRL	5	4000	RoHS & Green	NIPDAUAG	Level-1-260C-UNLIM	-40 to 125	(AGB, AGS)	Samples

(1) The marketing status values are defined as follows:

ACTIVE: Product device recommended for new designs.

LIFEBUY: TI has announced that the device will be discontinued, and a lifetime-buy period is in effect.

NRND: Not recommended for new designs. Device is in production to support existing customers, but TI does not recommend using this part in a new design.

PREVIEW: Device has been announced but is not in production. Samples may or may not be available.

OBSOLETE: TI has discontinued the production of the device.

(2) **RoHS:** TI defines "RoHS" to mean semiconductor products that are compliant with the current EU RoHS requirements for all 10 RoHS substances, including the requirement that RoHS substance do not exceed 0.1% by weight in homogeneous materials. Where designed to be soldered at high temperatures, "RoHS" products are suitable for use in specified lead-free processes. TI may reference these types of products as "Pb-Free".

RoHS Exempt: TI defines "RoHS Exempt" to mean products that contain lead but are compliant with EU RoHS pursuant to a specific EU RoHS exemption.

Green: TI defines "Green" to mean the content of Chlorine (Cl) and Bromine (Br) based flame retardants meet JS709B low halogen requirements of ≤ 1000 ppm threshold. Antimony trioxide based flame retardants must also meet the ≤ 1000 ppm threshold requirement.

(3) MSL, Peak Temp. - The Moisture Sensitivity Level rating according to the JEDEC industry standard classifications, and peak solder temperature.

(4) There may be additional marking, which relates to the logo, the lot trace code information, or the environmental category on the device.

(5) Multiple Device Markings will be inside parentheses. Only one Device Marking contained in parentheses and separated by a "~" will appear on a device. If a line is indented then it is a continuation of the previous line and the two combined represent the entire Device Marking for that device.

(6) Lead finish/Ball material - Orderable Devices may have multiple material finish options. Finish options are separated by a vertical ruled line. Lead finish/Ball material values may wrap to two lines if the finish value exceeds the maximum column width.

Important Information and Disclaimer: The information provided on this page represents TI's knowledge and belief as of the date that it is provided. TI bases its knowledge and belief on information provided by third parties, and makes no representation or warranty as to the accuracy of such information. Efforts are underway to better integrate information from third parties. TI has taken and continues to take reasonable steps to provide representative and accurate information but may not have conducted destructive testing or chemical analysis on incoming materials and chemicals. TI and TI suppliers consider certain information to be proprietary, and thus CAS numbers and other limited information may not be available for release.

In no event shall TI's liability arising out of such information exceed the total purchase price of the TI part(s) at issue in this document sold by TI to Customer on an annual basis.

OTHER QUALIFIED VERSIONS OF SN74AHC1G32 :

- Automotive : [SN74AHC1G32-Q1](#)

NOTE: Qualified Version Definitions:

- Automotive - Q100 devices qualified for high-reliability automotive applications targeting zero defects

TAPE AND REEL INFORMATION

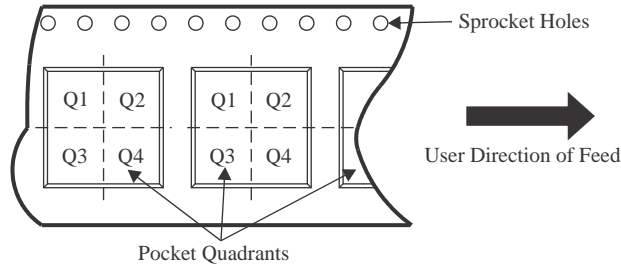
QUADRANT ASSIGNMENTS FOR PIN 1 ORIENTATION IN TAPE

*All dimensions are nominal

Device	Package Type	Package Drawing	Pins	SPQ	Reel Diameter (mm)	Reel Width W1 (mm)	A0 (mm)	B0 (mm)	K0 (mm)	P1 (mm)	W (mm)	Pin1 Quadrant
SN74AHC1G32DBVR	SOT-23	DBV	5	3000	180.0	8.4	3.2	3.2	1.4	4.0	8.0	Q3
SN74AHC1G32DBVR	SOT-23	DBV	5	3000	178.0	9.0	3.3	3.2	1.4	4.0	8.0	Q3
SN74AHC1G32DBVRG4	SOT-23	DBV	5	3000	178.0	9.0	3.23	3.17	1.37	4.0	8.0	Q3
SN74AHC1G32DCKR	SC70	DCK	5	3000	180.0	8.4	2.3	2.5	1.2	4.0	8.0	Q3
SN74AHC1G32DCKRG4	SC70	DCK	5	3000	178.0	9.2	2.4	2.4	1.22	4.0	8.0	Q3
SN74AHC1G32DCKTG4	SC70	DCK	5	250	178.0	9.2	2.4	2.4	1.22	4.0	8.0	Q3
SN74AHC1G32DRLR	SOT-5X3	DRL	5	4000	180.0	8.4	1.98	1.78	0.69	4.0	8.0	Q3

TAPE AND REEL BOX DIMENSIONS



*All dimensions are nominal

Device	Package Type	Package Drawing	Pins	SPQ	Length (mm)	Width (mm)	Height (mm)
SN74AHC1G32DBVR	SOT-23	DBV	5	3000	210.0	185.0	35.0
SN74AHC1G32DBVR	SOT-23	DBV	5	3000	180.0	180.0	18.0
SN74AHC1G32DBVRG4	SOT-23	DBV	5	3000	180.0	180.0	18.0
SN74AHC1G32DCKR	SC70	DCK	5	3000	210.0	185.0	35.0
SN74AHC1G32DCKRG4	SC70	DCK	5	3000	180.0	180.0	18.0
SN74AHC1G32DCKTG4	SC70	DCK	5	250	180.0	180.0	18.0
SN74AHC1G32DRLR	SOT-5X3	DRL	5	4000	202.0	201.0	28.0

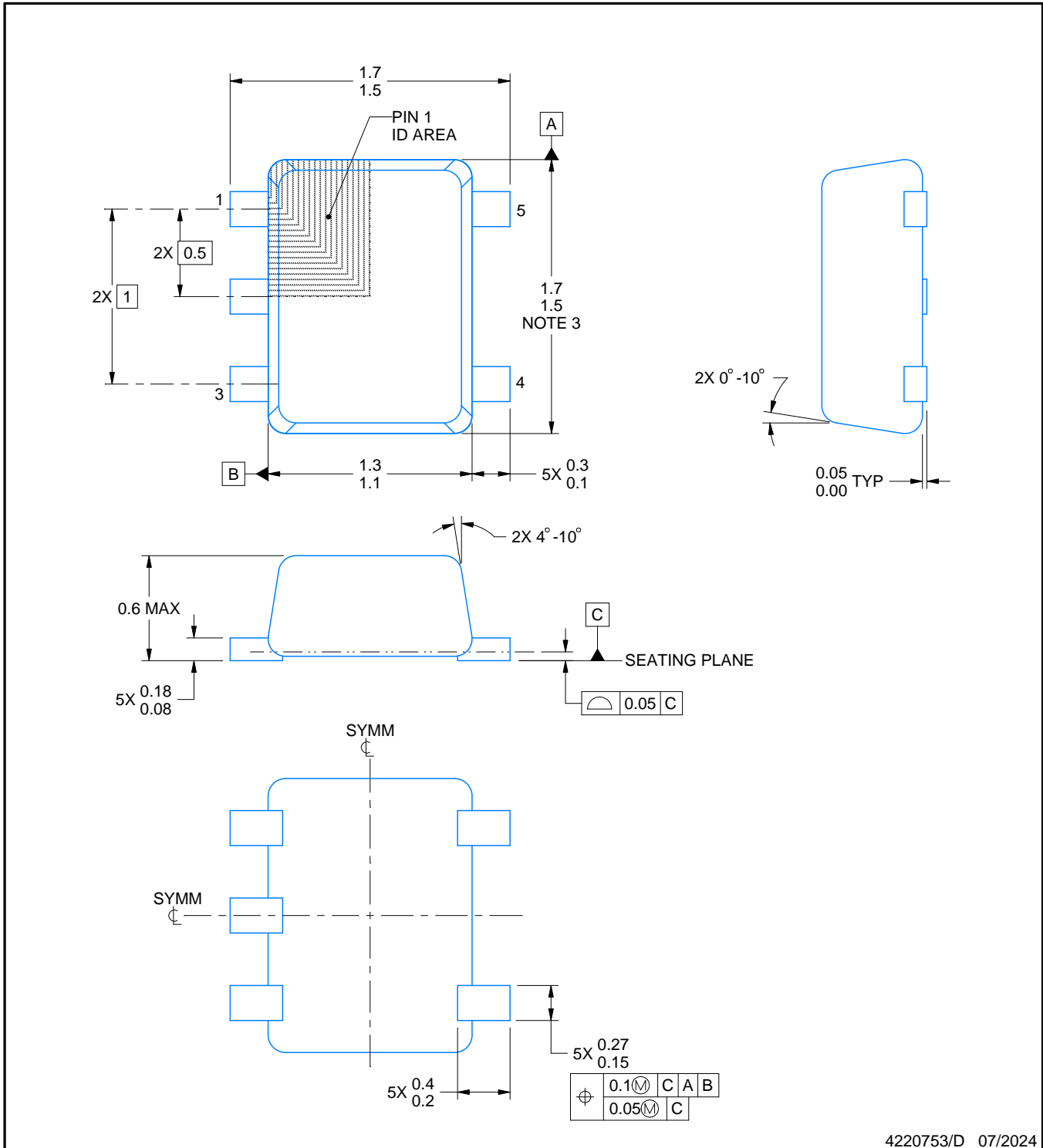
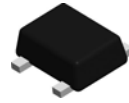

4220753/D 07/2024

NOTES:

1. All linear dimensions are in millimeters. Any dimensions in parenthesis are for reference only. Dimensioning and tolerancing per ASME Y14.5M.
2. This drawing is subject to change without notice.
3. This dimension does not include mold flash, protrusions, or gate burrs. Mold flash, protrusions, or gate burrs shall not exceed 0.15 mm per side.
4. Reference JEDEC registration MO-293 Variation UAAD-1

EXAMPLE BOARD LAYOUT

DRL0005A

SOT - 0.6 mm max height

PLASTIC SMALL OUTLINE

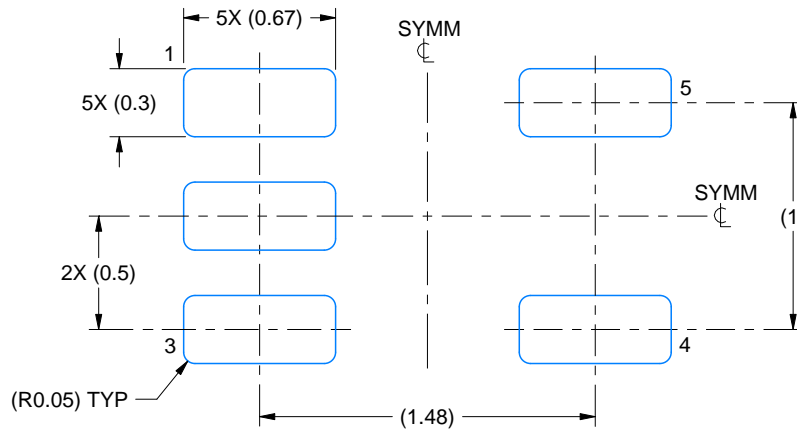

LAND PATTERN EXAMPLE
SCALE:30X

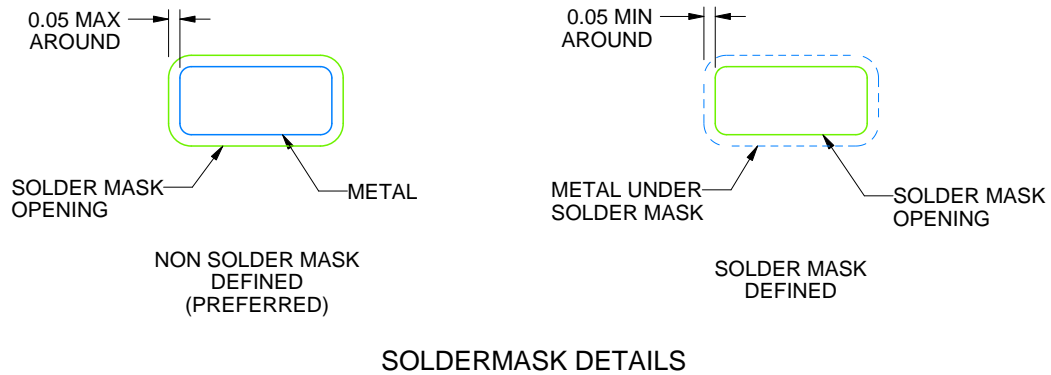

SOLDERMASK DETAILS

4220753/D 07/2024

NOTES: (continued)

- 5. Publication IPC-7351 may have alternate designs.
- 6. Solder mask tolerances between and around signal pads can vary based on board fabrication site.

EXAMPLE STENCIL DESIGN

DRL0005A

SOT - 0.6 mm max height

PLASTIC SMALL OUTLINE

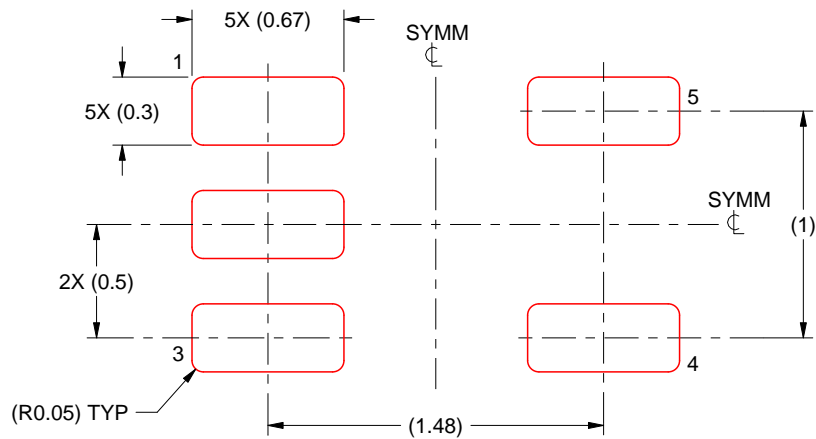

SOLDER PASTE EXAMPLE
BASED ON 0.1 mm THICK STENCIL
SCALE:30X

4220753/D 07/2024

NOTES: (continued)

7. Laser cutting apertures with trapezoidal walls and rounded corners may offer better paste release. IPC-7525 may have alternate design recommendations.
8. Board assembly site may have different recommendations for stencil design.

EXAMPLE BOARD LAYOUT

DCK0005A

SOT - 1.1 max height

SMALL OUTLINE TRANSISTOR

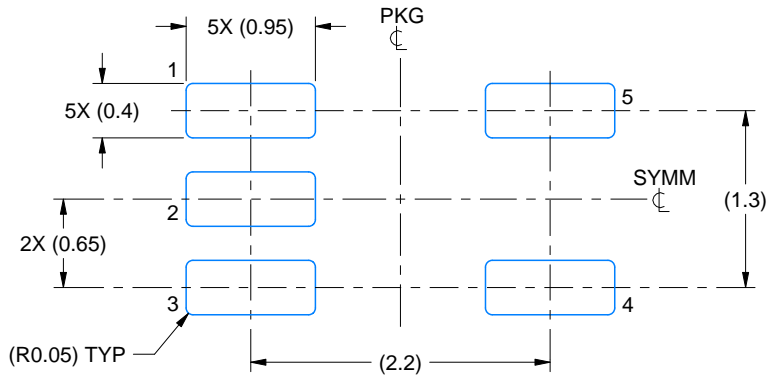

LAND PATTERN EXAMPLE
EXPOSED METAL SHOWN
SCALE:18X

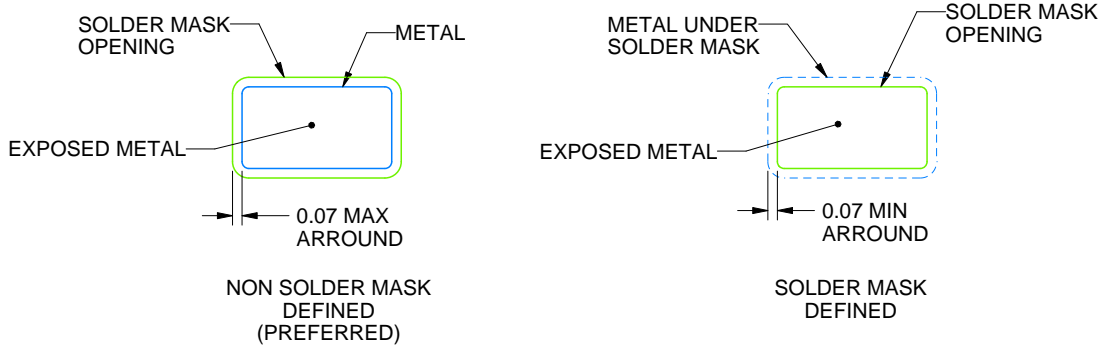

SOLDER MASK DETAILS

4214834/F 08/2024

NOTES: (continued)

- 7. Publication IPC-7351 may have alternate designs.
- 8. Solder mask tolerances between and around signal pads can vary based on board fabrication site.

EXAMPLE STENCIL DESIGN

DCK0005A

SOT - 1.1 max height

SMALL OUTLINE TRANSISTOR

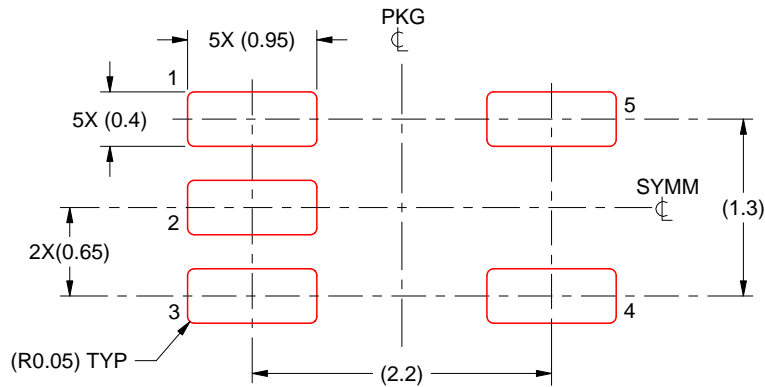

SOLDER PASTE EXAMPLE
BASED ON 0.125 THICK STENCIL
SCALE: 18X

4214834/F 08/2024

NOTES: (continued)

9. Laser cutting apertures with trapezoidal walls and rounded corners may offer better paste release. IPC-7525 may have alternate design recommendations.
10. Board assembly site may have different recommendations for stencil design.

EXAMPLE BOARD LAYOUT

DBV0005A

SOT-23 - 1.45 mm max height

SMALL OUTLINE TRANSISTOR



LAND PATTERN EXAMPLE
EXPOSED METAL SHOWN
SCALE:15X



SOLDER MASK DETAILS

4214839/K 08/2024

NOTES: (continued)

- 6. Publication IPC-7351 may have alternate designs.
- 7. Solder mask tolerances between and around signal pads can vary based on board fabrication site.

EXAMPLE STENCIL DESIGN

DBV0005A

SOT-23 - 1.45 mm max height

SMALL OUTLINE TRANSISTOR



SOLDER PASTE EXAMPLE
BASED ON 0.125 mm THICK STENCIL
SCALE:15X

4214839/K 08/2024

NOTES: (continued)

8. Laser cutting apertures with trapezoidal walls and rounded corners may offer better paste release. IPC-7525 may have alternate design recommendations.
9. Board assembly site may have different recommendations for stencil design.

IMPORTANT NOTICE AND DISCLAIMER

TI PROVIDES TECHNICAL AND RELIABILITY DATA (INCLUDING DATA SHEETS), DESIGN RESOURCES (INCLUDING REFERENCE DESIGNS), APPLICATION OR OTHER DESIGN ADVICE, WEB TOOLS, SAFETY INFORMATION, AND OTHER RESOURCES "AS IS" AND WITH ALL FAULTS, AND DISCLAIMS ALL WARRANTIES, EXPRESS AND IMPLIED, INCLUDING WITHOUT LIMITATION ANY IMPLIED WARRANTIES OF MERCHANTABILITY, FITNESS FOR A PARTICULAR PURPOSE OR NON-INFRINGEMENT OF THIRD PARTY INTELLECTUAL PROPERTY RIGHTS.

These resources are intended for skilled developers designing with TI products. You are solely responsible for (1) selecting the appropriate TI products for your application, (2) designing, validating and testing your application, and (3) ensuring your application meets applicable standards, and any other safety, security, regulatory or other requirements.

These resources are subject to change without notice. TI grants you permission to use these resources only for development of an application that uses the TI products described in the resource. Other reproduction and display of these resources is prohibited. No license is granted to any other TI intellectual property right or to any third party intellectual property right. TI disclaims responsibility for, and you will fully indemnify TI and its representatives against, any claims, damages, costs, losses, and liabilities arising out of your use of these resources.

TI's products are provided subject to [TI's Terms of Sale](#) or other applicable terms available either on [ti.com](https://www.ti.com) or provided in conjunction with such TI products. TI's provision of these resources does not expand or otherwise alter TI's applicable warranties or warranty disclaimers for TI products.

TI objects to and rejects any additional or different terms you may have proposed.

Mailing Address: Texas Instruments, Post Office Box 655303, Dallas, Texas 75265
Copyright © 2024, Texas Instruments Incorporated