

Side View Chip LEDs 0605<1.6 × 1.15 t=0.55mm> Standard Type

SML-A12*8 Series

Side View

EXCELEDTM

Emitting Color	Pure Green	Green(Yellowish Green)	Yellow	Orange	Red	
Material	AlGaInP on GaAs					
Package Size(mm)						
Part No.	SML-A12P8T	SML-A12M8T	SML-A12Y8T	SML-A12D8T	SML-A12U8T	SML-A12V8T

Absolute Maximum Ratings (Ta=25°C)

Part No.	Emitting color	Power dissipation Pd (mW)	Forward current IF (mA)	Peak forward current I _{FP} * (mA)	Reverse voltage VR (V)	Operating temperature T _{opr} (°C)	Storage temperature T _{stg} (°C)
SML-A12P8T	Pure Green	54	20	100	5	-40 to +85	-40 to +100
SML-A12M8T	Green (Yellowish Green)						
SML-A12Y8T	Yellow	54	20	100	5	-40 to +85	-40 to +100
SML-A12D8T	Orange						
SML-A12U8T	Red	54	20	100	5	-40 to +85	-40 to +100
SML-A12V8T							

*:Duty ≤ 1/10, 1kHz.

Electrical Optical Characteristics (Ta=25°C)

Part No.	Resin Color	Forward voltage VF		Reverse current IR		Light wavelength		Brightness Iv		
		Typ. (V)	IF* (mA)	Max. (μA)	VR (V)	Dominant λD Typ. (nm)	IF* (mA)	Min. (mcd)	Typ. (mcd)	IF* (mA)
SML-A12P8T	Transparent Colorless	2.2	20	10	5	560	20	2.5	6.3	20
SML-A12M8T						572		10	25	
SML-A12Y8T						590		25	63	
SML-A12D8T						605		40	100	
SML-A12U8T						620		25	63	
SML-A12V8T						630		16	40	

*Pulse width : 30ms

Dimensions (Unit:mm)

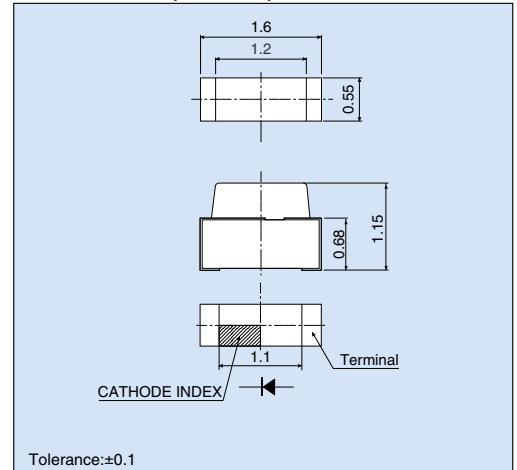

Directivity (Typ.)

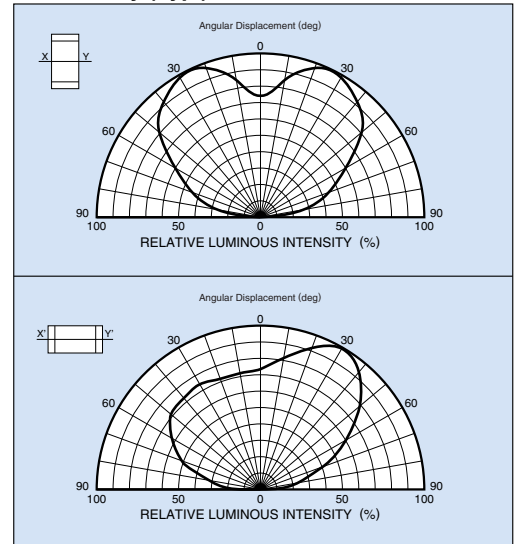

Recommended Pad Layout

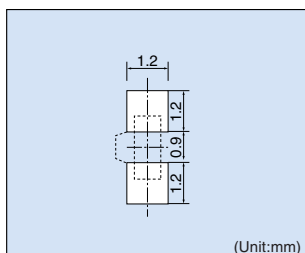

The recommended thickness of the screen mask for soldering is more than 150μm. The hole size of the screen mask should be same as the recommended land pattern or smaller.

Packaging Specifications (Unit:mm)

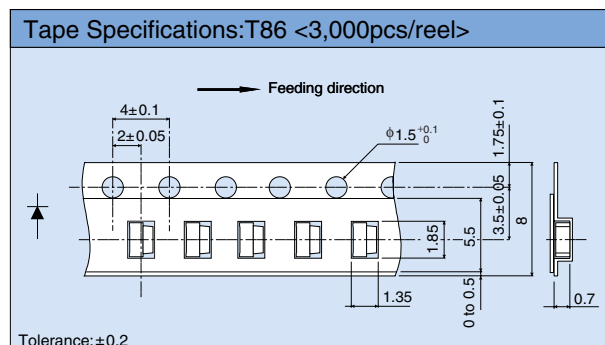

Reel Specifications

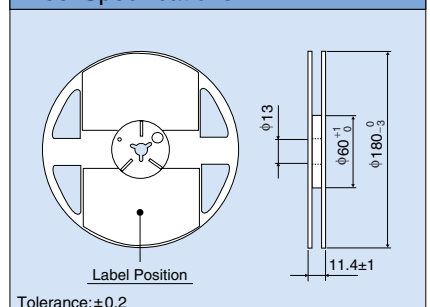

Electrical Characteristic Curves

Forward Current - Forward Voltage

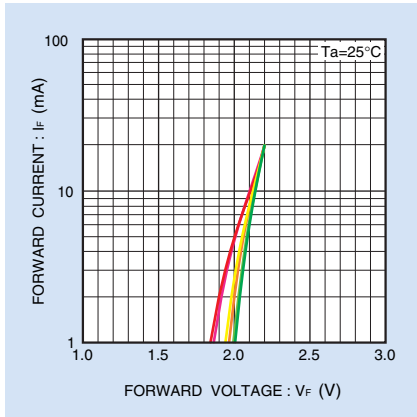

- SML-A12P8T
- SML-A12M8T
- SML-A12Y8T
- SML-A12D8T
- SML-A12U8T
- SML-A12V8T

Relative Luminous Intensity - Case Temperature

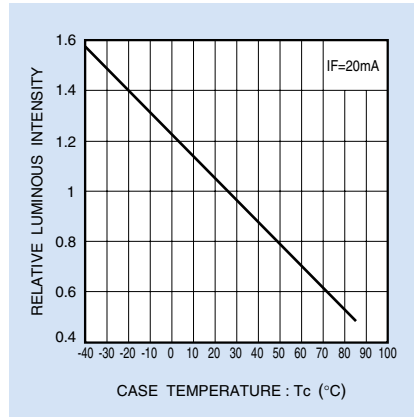

- SML-A12P8T
- SML-A12M8T
- SML-A12Y8T
- SML-A12D8T
- SML-A12U8T
- SML-A12V8T

Relative Luminous Intensity - Forward Current

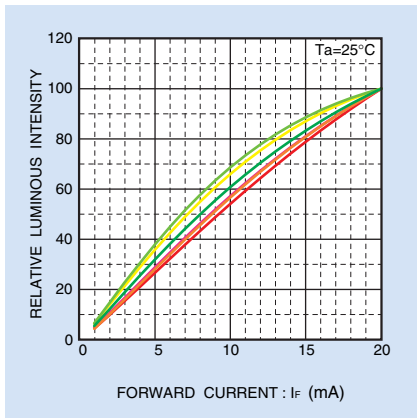

- SML-A12P8T
- SML-A12M8T
- SML-A12Y8T
- SML-A12D8T
- SML-A12U8T
- SML-A12V8T

Ratio of Maximum Tolerable Peak Current - Pulse Duration

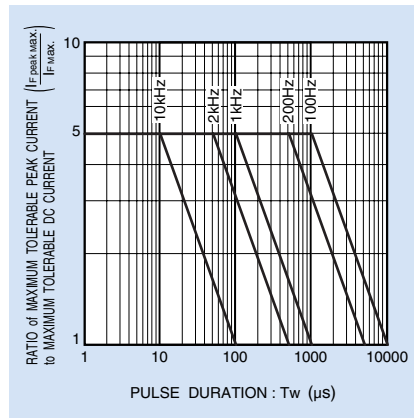

- SML-A12P8T
- SML-A12M8T
- SML-A12Y8T
- SML-A12D8T
- SML-A12U8T
- SML-A12V8T

Derating

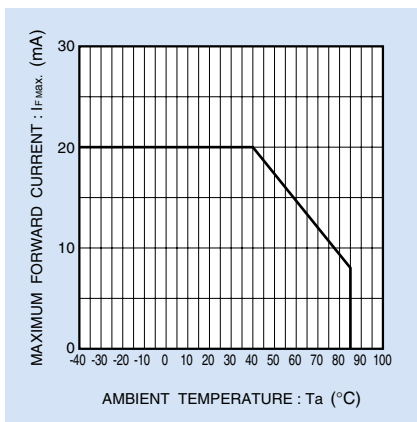

- SML-A12P8T
- SML-A12M8T
- SML-A12Y8T
- SML-A12D8T
- SML-A12U8T
- SML-A12V8T

Notes

- No technical content pages of this document may be reproduced in any form or transmitted by any means without prior permission of ROHM CO.,LTD.
- The contents described herein are subject to change without notice. The specifications for the product described in this document are for reference only. Upon actual use, therefore, please request that specifications to be separately delivered.
- Application circuit diagrams and circuit constants contained herein are shown as examples of standard use and operation. Please pay careful attention to the peripheral conditions when designing circuits and deciding upon circuit constants in the set.
- Any data, including, but not limited to application circuit diagrams information, described herein are intended only as illustrations of such devices and not as the specifications for such devices. ROHM CO.,LTD. disclaims any warranty that any use of such devices shall be free from infringement of any third party's intellectual property rights or other proprietary rights, and further, assumes no liability of whatsoever nature in the event of any such infringement, or arising from or connected with or related to the use of such devices.
- Upon the sale of any such devices, other than for buyer's right to use such devices itself, resell or otherwise dispose of the same, no express or implied right or license to practice or commercially exploit any intellectual property rights or other proprietary rights owned or controlled by
- ROHM CO., LTD. is granted to any such buyer.
- Products listed in this document are no antiradiation design.

The products listed in this document are designed to be used with ordinary electronic equipment or devices (such as audio visual equipment, office-automation equipment, communications devices, electrical appliances and electronic toys).

Should you intend to use these products with equipment or devices which require an extremely high level of reliability and the malfunction of which would directly endanger human life (such as medical instruments, transportation equipment, aerospace machinery, nuclear-reactor controllers, fuel controllers and other safety devices), please be sure to consult with our sales representative in advance.

It is our top priority to supply products with the utmost quality and reliability. However, there is always a chance of failure due to unexpected factors. Therefore, please take into account the derating characteristics and allow for sufficient safety features, such as extra margin, anti-flammability, and fail-safe measures when designing in order to prevent possible accidents that may result in bodily harm or fire caused by component failure. ROHM cannot be held responsible for any damages arising from the use of the products under conditions out of the range of the specifications or due to non-compliance with the NOTES specified in this catalog.

Thank you for your accessing to ROHM product informations.

More detail product informations and catalogs are available, please contact your nearest sales office.

ROHM Customer Support System

THE AMERICAS / EUROPE / ASIA / JAPAN

www.rohm.com

Contact us : webmaster@rohm.co.jp